

STEAMIST®

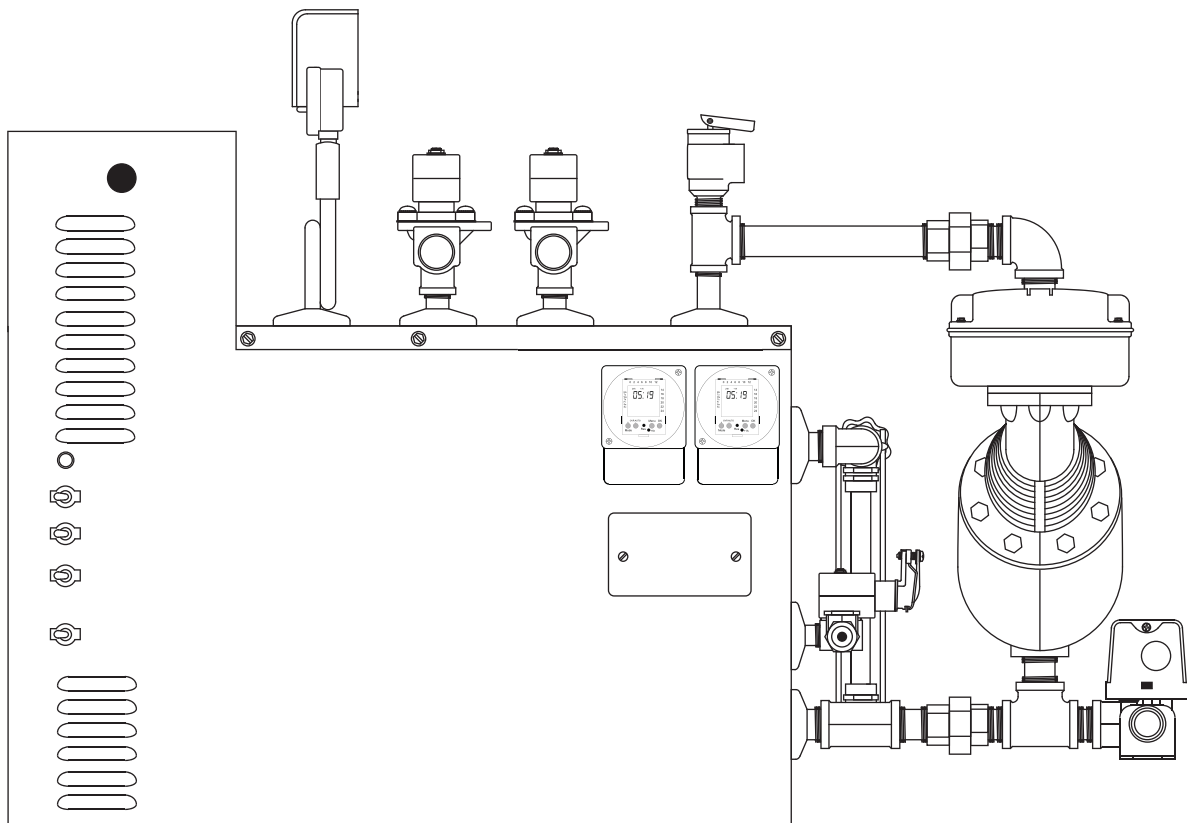

Heavy Commercial Steambath Generator

Models: HC-24 thru HC-72



Installation and Operation Instructions	Page
I. Plumbing Installation.....	4
A. Plumbing Pre-Installation.....	4
B. Plumbing Rough-In.....	4
C. Steam Generator Plumbing Installation.....	5
II. Electrical Installation.....	5
A. ELectrical Pre-Installation.....	5
B. Electrical Rough-In.....	5
C. Steam Generator Electrical Installation.....	5
III. CP-1 Control Package Installation & Operation.....	6
A. Pre-Constrcution Considerations.....	6
B. CP-1 Control Package Rough-In.....	7
C. CP-1 Control Package Installation.....	7
D. Steam Solenoid Valve.....	8
E. Operation.....	8
IV. Auto Blowdown & Automatic ON/OFF Time Clock.....	10
V. Steam Generator Operation.....	11
A. Manual Blowdown.....	11
B. Peroidic Inspection.....	11
VI. 24hr 7-day Clock Programming Instructions.....	12
 List of Illustrations	
1. Dimensional Drawing for Heavy Commercial Steam Generator (HC-24 thru HC-72).....	4
2. Typical Steam Generator Installation.....	6
3. ST-200C Temperature Sensor Installation.....	7
4. ST-200C Temperature Control Installation.....	8
5. System Control Module Installation.....	9
6. Installed CP-1 Control Package.....	10
7. "HC" Wiring Diagram with Option.....	14
 Warranty and Specifications	
Warranty.....	15
Specification Chart.....	16

IMPORTANT: Read all instructions before installing equipment

The Heavy Commercial steam generator (HC-24 thru HC-72) comes from the factory assembled, carefully wired, and tested. Please read all instructions before installing or servicing.

IMPORTANT:

1. All Plumbing and Electrical work must conform to local and national codes.
2. All power must be OFF to the steam generator when installing or servicing the unit.
3. Do not use or install unauthorized components, accessories or products on the generator or its piping.

WARNING: Elderly persons, pregnant women, or those suffering from heart disease, high blood pressure, diabetes, or not in good health must not use this device unless otherwise directed by a physician. Also, steambathing should be avoided while intoxicated.

I. Plumbing Installation:

A. Plumbing Pre-Installation

- 1) Insure that the model steam generator unit purchased is sized adequately for your steam room.

IMPORTANT: Refer to the specification plate affixed to the cabinet of the steam bath generator.

- 2) Allow sufficient room (72" x 30" x 30"H) for access to the unit in the event service is required. Do not keep flammable materials such as gasoline, thinners, paints, etc. in the same area as the steam generator.

- 3) The steam generator must be located as close as possible to the steam room. If the steam generator is more than ten feet from the steam head, insulate the steam pipe. The serial number plate should be visible. Refer to Figure 2 for installation drawing. Do not install outdoors or an area where parts may freeze or corrode. Also, do not install near combustible materials, i.e. paints, thinners, chlorine, etc.
- 4) The steam room must be completely sealed on both sides and top. Floor, walls, and ceiling should be completely covered with waterproof material. In the event that the walls or ceiling have exposed plaster, sheetrock, or plaster board, a waterproof paint must be applied to seal the surfaces.

B. Plumbing Rough-In:

The Heavy Commercial "HC" Steam Generator requires the following connections: ½" NPT piping for water inlet. ¾" NPT brass or 1" (I.D.) copper tubing for steam outlet, and ¾" NPT safety valve should be piped to an indirect waste line. A 1" minimum indirect waste line must be installed for the drain. This should be completed before the walls are installed. Before connecting the water line it is important to make sure the line is thoroughly clean and free of foreign matter.

- 1) Rough-in a water line from the cold water pipe. Brass pipe or copper tubing is recommended. A shut-off valve should be conveniently placed in the water feed line.

Figure 1 - Dimensional Drawing for Heavy Commercial Steam Generator (HC-24 thru HC-72)

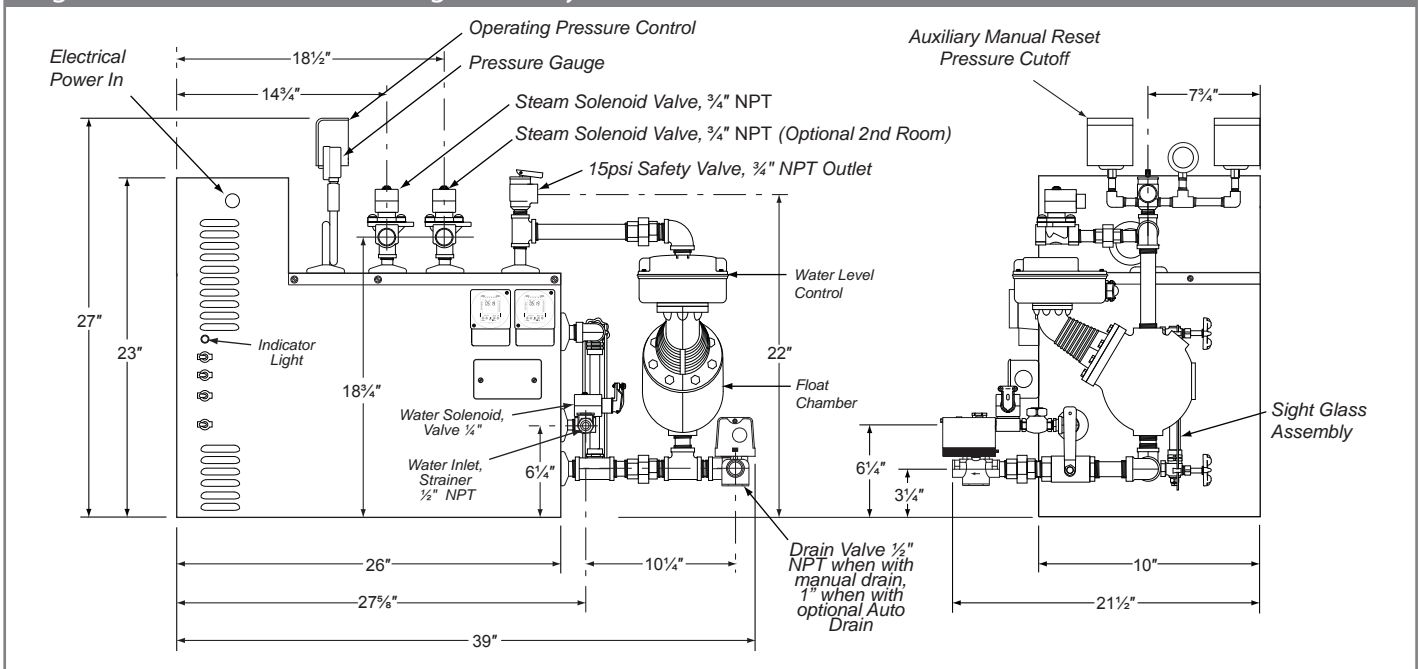

- 2) Rough-in the steam line using $\frac{3}{4}$ " NPT brass pipe or 1" I.D. copper tubing. Do not use iron pipe as it will rust and discolor the wall of steam room. For a steam line that is longer than 10 feet, an appropriate pipe insulation rated for a minimum of 212°F must be used. The steam head location should be approximately 12" to 18" above the steam room floor.

CAUTION: NO shut-off valve should be installed on the steam line. Do not create traps or valleys in this line which would trap condensation and block the flow of steam. The steam pipe should be pitched allowing condensation to run back into the steam generator or pitched toward the steam head.

- 3) Rough-in a $\frac{3}{4}$ " indirect waste line to be used for the safety valve. The indirect drain must be in accordance with local plumbing codes.
- 4) Rough-in a 1" indirect waste line to be used for the optional automatic blow-down. The indirect drain must be in accordance with local plumbing codes.

C. Steam Generator Plumbing Installation

Care must be taken when installing the steam generator. Leave proper access for servicing. Refer to Figure 2 for typical steam generator installation.

CAUTION: The steam generator is designed to be used ONLY in an upright and level position to do otherwise would damage the unit and void the warranty.

- 1) If needed mount the steam generator on a platform to allow draining into a basin or into a previously installed indirect waste line.

NOTE: Optional automatic blowdown must be piped into a 1" indirect waste line.
- 2) Connect the $\frac{3}{4}$ " NPT safety valve into the previously installed indirect waste line.
- 3) In areas where high water pressure may be a problem a water hammer arrestor should be installed. Connect the water supply to the steam generator connection marked "water inlet" (see Figure 1).
- 4) Connect the steam line from the previously roughed-in location to the steam generator marked "Steam Outlet" (see Figure 1).
- 5) In the steam room, place the center of the escutcheon onto the steam pipe and screw the steam head into place. Care must be taken not

to scratch the steam head or escutcheon with a wrench. Be sure the steam slot in the steam head is facing down.

After the plumbing connections are complete the electrician may finish the wiring and test the unit.

II. Electrical Installation:

A. Electrical Pre-Installation

- 1) Proper electrical supply: see serial number plate for information (see Figure 1). Determine proper size of wire, voltage, amperage, and phase for the steam generator.
- 2) Inline fuse/circuit breaker required: fuse or circuit breaker sized in accordance with specification chart see page 16. Do not install a (GFI) Ground Fault Interrupter to this equipment.

B. Electrical Rough-In

- 1) Route power supply cable to the location the steam generator will be installed before walls are closed.

C. Steam Generator Electrical Installation

WARNING: All power to the steam generator must be turned off.

- 1) Locate and open the electrical access cover (see Figure 1).
- 2) Locate appropriate knockout found at the top of the steam generator. Mount proper strain relief into knockout hole.
- 3) Strip back the power cable's outer insulation jacket twelve (12) inches and insert into steam generator. Strip back insulation $\frac{1}{2}$ " from the incoming wires: single phase (two power one ground) or 3 phase (three power one ground).
- 4) Insert ground wire into grounding lug located inside cabinet.

CAUTION: Insure ground wire does not come in contact with live electrical connections.

- 5) Locate the power terminal block. Insert power wires into the proper power lug terminals on the top of the terminal block and secure.
- 6) Close cover removed in step 1.

7) If connections are made properly the indicator lamp will illuminate when the generator is on and heating.

NOTE: Steam generator will not operate without water.

III. CP-1 Control Package Installation and Operation

The CP-1 Control Package is completely automatic in operation. The room temperature is thermostatically controlled by the Steamist ST-200C Solid State Temperature Control System in conjunction with the generator's steam solenoid valve.

The "Rapid Response" ST-200C Temperature Control System is made up of three components: Temperature Sensor Probe (Figure 3), Temperature Control Panel (Figure 4), and the System Control

Module (Figure 5). After wiring to the ST-200C is complete the steam room temperature will automatically be maintained within 1-1/2°F of the desired setting at the location of the sensor.

NOTE: This control is not an ON/OFF switch, it is used in conjunction with the Steam Solenoid Valve. The steam generator cannot be turned OFF with this device.

A. Pre-Construction Consideration

Choose a location to mount the Temperature Control Panel. Only a manager or limited group should be in charge of controlling the steam bath temperature, a utility area or a lock box outside the steam room may be appropriate.

Figure 2 - Typical Steam Generator Installation

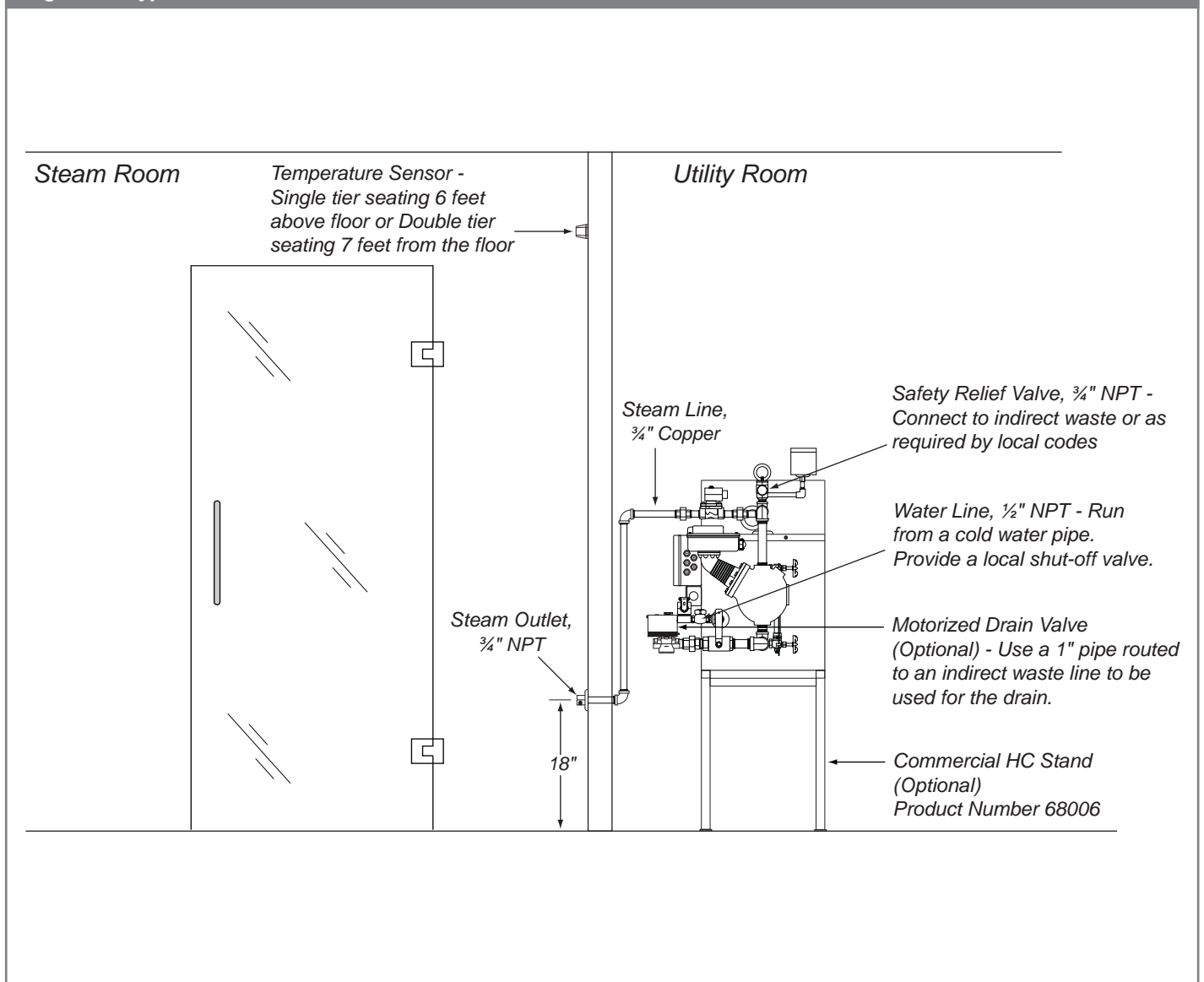

Mount the Temperature Control Panel outside of the steam room. Mount the Temperature Sensor Probe inside the steam room.

WARNING: All electrical power to the steam generator **MUST** be turned OFF before proceeding with installation.

B. CP-1 Control Package Rough-In

The 3 wire cable for Temperature Control Panel to be used during wiring of the ST200-C Solid State Temperature Control System is low voltage, 18 or 22 AWG wire is recommended. Every attempt should be made to match the color wire of the Temperature Control Potentiometer lead wires (P1 white, P2 Black, and P3 Red) to the 3 wire cable.

- 1) Install a metal two-gang switch box rotated 90° (refer to Figure 4). Install an inverted strain relief clamp and feed the 3 wire cable into the two-gang box. Run the 3 wire cable from the switch box to the steam generator's location.
- 2) Install a two conductor cable from the area of the Temperature Sensor (Probe) to the steam generator's location. The Temperature Sensor (Probe) **MUST** be located inside the steam room. In steam rooms with single tier seating the Sensor should be located 6 feet above the floor, with two tier seating it should be 7 feet above the floor and in either case away from

the steam head and steam room door.

NOTE: A 5/8 inch hole should be provided so that the back end of the sensor and its wiring can be passed through the wall for installation found later in these instructions.

C. CP-1 System Control Package Installation

- 1) Temperature Sensor Probe (for installation inside the steam room)
 - a. Locate the 2 wire cable described in the Rough-In section.
 - b. Keeping the 5/8 inch hole centered, drill two 1/4 holes 2 inches apart. Insert 2-No. 8 plastic anchors into drilled holes.
 - c. Follow Figure 3.
- 2) Temperature Control Panel (for installation outside the steam room)
 - a. Attach the 3 wires (P1, P2, and P3) from the Temperature Control Potentiometer to the 3 wire cable in the two-gang box. Make sure the colors of wire P1, P2, and P3 are attached to match the colors of the 3 wire cable to the potentiometer wire colors.

Figure 3 - Sensor Installation - Inside Steamroom

NOTE: Location of the sensor is as follows:
 a) Single tier seating - 6 feet above floor.
 b) Double tier seating - 7 feet above floor.

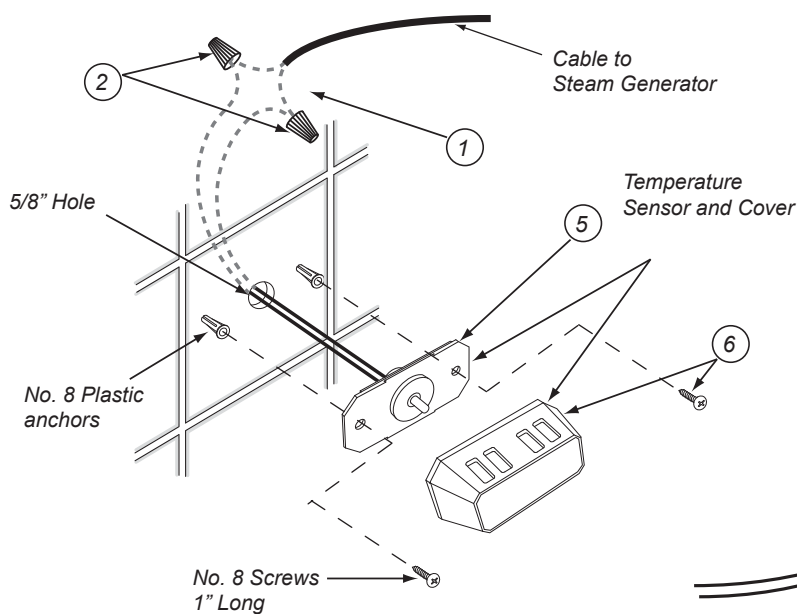

Steps to Install Sensor

1. Separate two wires of the cable (coming thru wall from the generator's ST-200C circuit board, terminal #2 and #4) Approximately 2", strip and twist approximately 1/2" of bare wire.
2. Take new sensor assembly and twist wires to wall cable and secure with wire nuts.
3. Peel off adhesive backing from sensor.
4. Carefully apply silicone sealant around rear edge.
5. Feed wires back into wall and press sensor firmly to the wall (be careful to align plate holes with anchor holes).
6. Install screws, snap chrome cover back in place.
7. Temperature sensor assembly must form a 100% water tight seal to seal to the wall using silicone supplied.

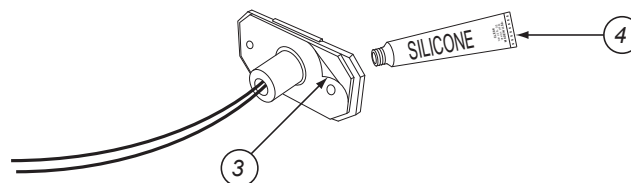

b. Secure Temperature Face Plate to the two-gang box using four (4) machine screws (see Figure 4).

IMPORTANT: Care must be taken to mount Temperature Face Plate properly.

The temperature of the steam bath is regulated automatically by the ST200-C Temperature Control System which turns "ON or OFF," the Steam Solenoid Valve located on the steam generator allowing steam to enter the room.

3) System Control Module

- a. Remove screws securing cover to System Control Module and remove cover (Figure 5).
- b. Feed the 3 wire cable through the top strain relief, three inches into the control module. Attach wires as shown in Figure 5.
- c. Feed the 2 wire cable through the lower strain relief, three inches into the control module. Attach wires as shown in Figure 5.
- d. Check that all connections are made in accordance with Wiring Diagram (see Figure 6).
- e. Replace control module cover.

D. Steam Solenoid Valve

There is no installation required for the steam solenoid valve, it is factory installed and wired.

E. Operation

Figure 4 - ST200-C Temperature Control Installation (Outside Steam Room)

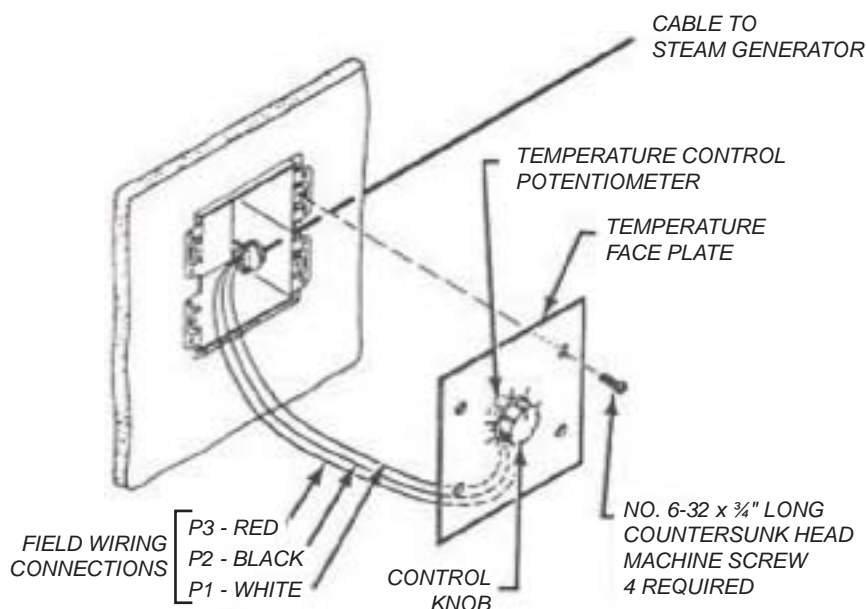

CP-1 Control Package

Models: HC-24 thru HC-72

To increase the temperature, turn the knob on the Temperature Control Panel clockwise. The higher the number, the higher the setting (numbered 1 to 10).

To decrease the temperature, turn the knob counter-clockwise.

Once a desired temperature setting has been established there should be no further need for additional adjustments.

IMPORTANT: To check the function, two lights are provided on the exterior of the System Control Module located on the steam generator. The "Red Light" indicates there is electrical power to the Temperature Control Module. The "Green Light" indicates the Steam Solenoid Valve is energized.

Figure 5 - System Control Module Wiring

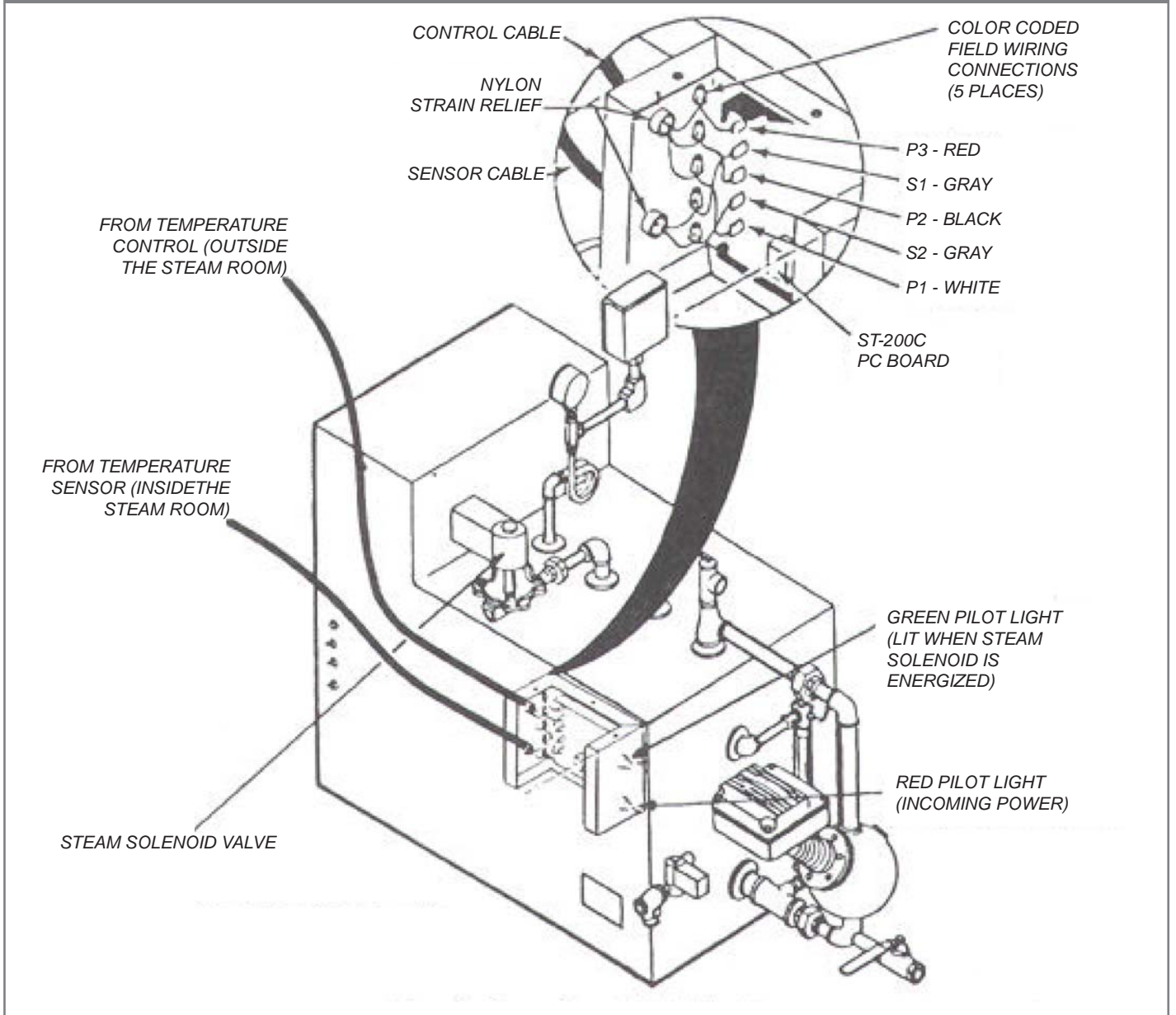

IV. Auto Blowdown and Auto ON/OFF Time Clocks (Optional)

The "HC" steam generator, with an optional auto blowdown system, will automatically purge the steam boiler. Working in conjunction, the time clock and electrically motorized valve, which allows blowdown on boilers, prevents excessive mineral and scale build-up.

A. Installation

1) Auto Blowdown Drain Valve (plumbing)

Attach the main blowdown drain valve to 1" indirect drain (most local codes require a blowdown tank). A strainer must not be used with the valve.

NOTE: the drain line must be angled downward, allowing gravity to properly drain the machine.

2) Auto Blowdown (electrical)

All wiring is done at the factory so that no special electrical wiring is necessary.

B. Operation

First decide the TIME OF DAY you require the boiler to blowdown. It is recommended to select a time while the boiler is in use, but under low demand. For the best results program the timer to blowdown every day of use for a period of 5 minutes.

Figure 6 - Sensor Installation - Inside Steamroom

NOTE: Location of sensor is as follows
 a) Single tier seating - 6 feet above floor.
 b) Double tier seating - 7 feet above the floor.

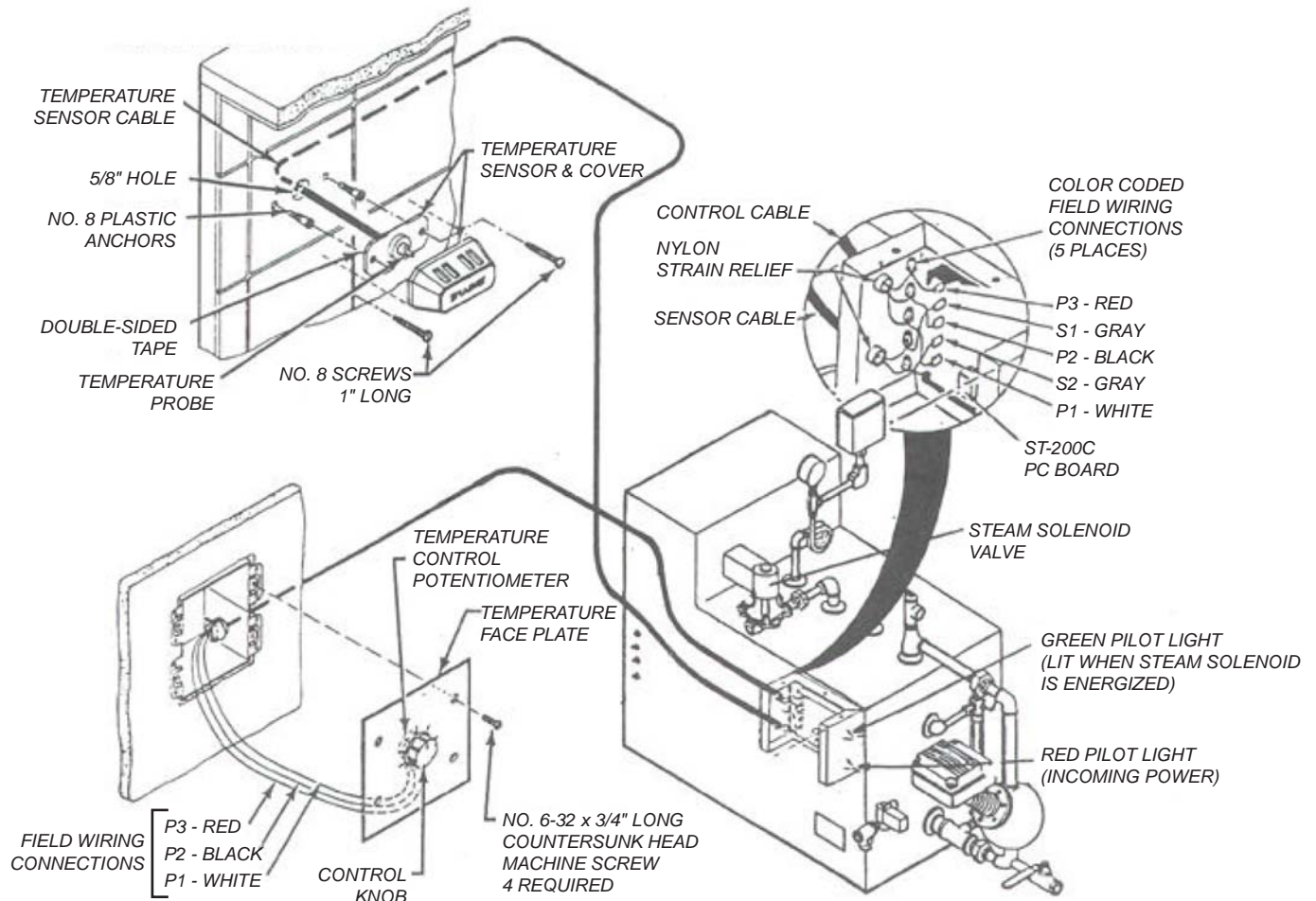

The blowdown will begin with the timer "ON" command and end with the timer "OFF" command (see Pages 12 and 13).

C. Setting Automatic ON/OFF Time Clock (Optional)

The steam generator will turn ON with the timer "ON" command and OFF with the timer "OFF" command (see Pages 12 and 13).

IMPORTANT: The Auto Blowdown Timer and Auto ON/OFF Timer are two separate timers. If your steam generator only has one timer, then only one of these two options can be programmed. Check with the installer to see which option has been purchased.

V. Steam Generator Operation

- A. Place START, WATER SOLENOID, and STEAM SOLENOID switches in the ON position. The Water Solenoid Valve will open and the boiler will fill to its proper level (about two-thirds of the site glass full) and automatically shut-off.
- B. When there is adequate water in the boiler the power contactor will energize and the red power light (located above the toggle switches) will illuminate indicating that the boiler is heating up.

Both the water feed and low water cut-off functions are regulated by a McDonnell/Miller 150 series control and low water cut-off, depending on the water level within the boiler which, in turn, energizes the water solenoid valve and/or power contactor.

- C. When adequate steam has been generated from the boiler and the desired temperature reached in the steam room the steam solenoid valve will close when controlled by the ST-200C. The steam room is now ready for use.

NOTE: When the steam solenoid valve closes the red pilot light above the toggle switches will go out only after steam pressure builds to approximately 5 to 10 PSI within the boiler.

- D. With the ST-200C Temperature Control System (Thermostat) set the dial to the desired temperature (Dial Calibration: 1 to 10 setting for comfort level). Refer to Section III for Operating Instructions.
- E. If an Automatic ON/OFF Time Clock is provided, set "the timer cycle" in order to operate.

VI. Steam Generator Maintenance

A. Manual Blowdown (Only if NOT equipped with Automatic Blowdown)

The boiler should be drained on a daily basis to purge the vessel of mineral deposits and possible

scaling. For effective blowdown, the WATER, and START switches must be placed in the OFF position. The drain valve should be opened completely, allowing the boiler water to exit through your drainage piping into an indirect drain. Now, place the water solenoid switch in the ON position allowing the system to flush through for approximately 5 minutes. Close the drain valve and allow the boiler to fill with water until the proper level has been reached. The generator is again ready for use, place the START switch in the ON position.

B. Periodic Inspection

CAUTION: Disconnect all power to the boiler before servicing. Service should be performed by a qualified person.

- 1) Check electrical connections periodically to ensure that they are tight.
- 2) Remove the lower section of the McDonnell/Miller 150 series Control and low water cut-off periodically to check for deposits. Check that the float and rod inside the round chamber are not coated with deposits and the float moves freely without sticking. Check that the bottom pipes from the boiler opening to the float chamber are free from debris.
- 3) Remove flange-type heating elements to clean any scale that might have built on sheaths. Be careful when cleaning heating elements not to damage the rods.

24hr 7-day Clock Programming Instructions

VII. Time Clock 24-hr 7-day Program

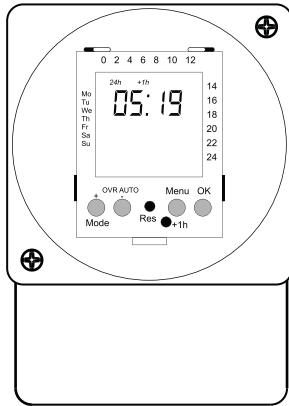

Safety Precautions

Program Structure

Symbols, keys

Setting the timer

Setting the 24h or am/pm clock, time and weekday

Pre-Set programs

Selecting pre-set programs P01 to P03

User defined programs

Deleting programs

Summer / Winter time

Automatic operation / fixed ON / fixed OFF

Safety Precautions

- The connection and installation of electrical devices may only be carried out by a qualified electrician.
- Interventions in and changes to the device result in the voiding of the warranty claim.
- Observe your national regulations and the respective safety provisions.
- Switch-off commands have priority over switch-on commands.

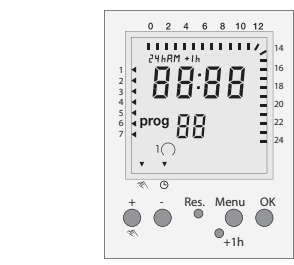
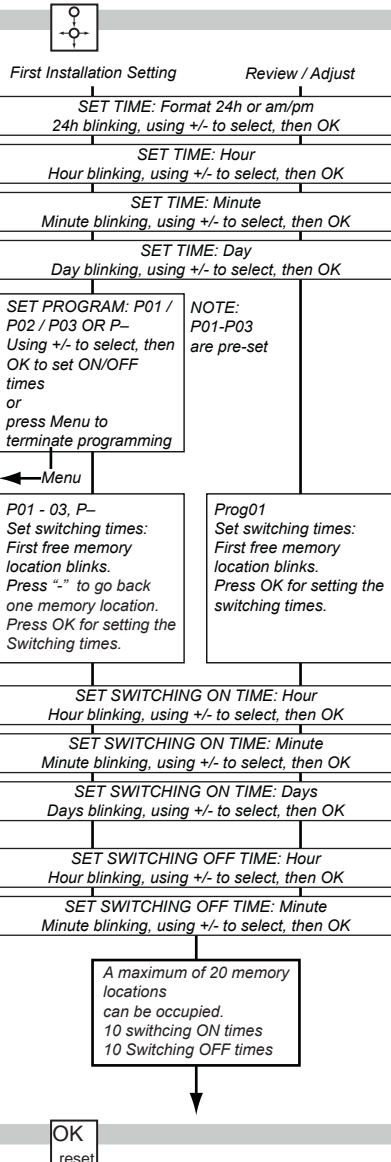

- : Overview of daily switching program
- 24hRM : Setting of 24h or am/pm
- +1h : Summer/Winter clock changes
- ◀ : Weekday display
- : Switching status display ON/OFF
- ⚡ : Manual operation / advance ON / advance OFF
- ⊙ : Automatic operation
- +/- : Adjustment keys:
By pressing the key longer than 2 sec. you can adjust the timer in steps of 5 units
- Res. : Reset
- Menu : By pressing the Menu key programming is terminated and the system reverts to automatic operation
- OK : Confirmation of programming

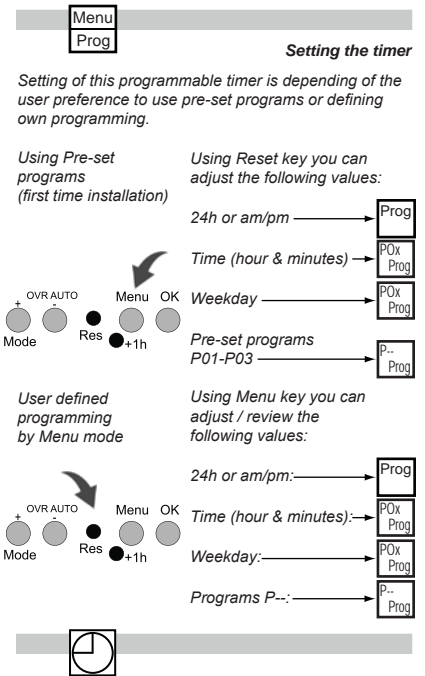

Sequence to follow after selecting programming by pre-set programs or Menu mode.

Set display format 24h or am/pm

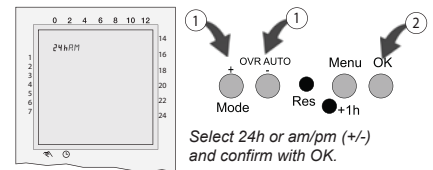

Set Hour

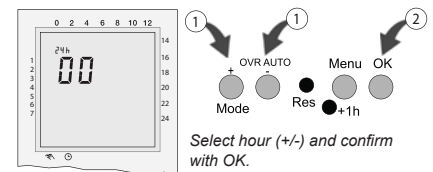

Set minutes

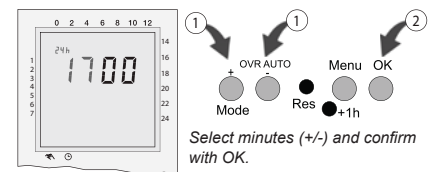

Set weekday

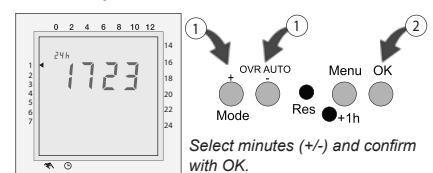

- 1 = Monday
- 2 = Tuesday
- 3 = Wednesday
- 4 = Thursday
- 5 = Friday
- 6 = Saturday
- 7 = Sunday

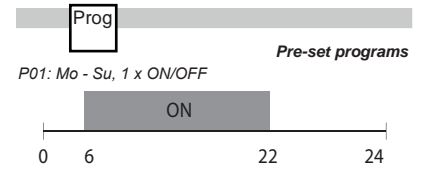

24hr 7-day Clock Programming Instructions

Models: HC-24 thru HC-72

Prog

Continued...

P02: Mo - Su, 2 x ON/OFF

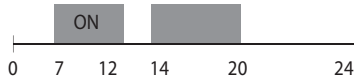

P03: Mo - Su, 3 x ON/OFF

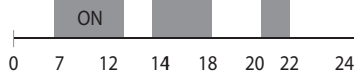

Programs P01-03

The switching on and off times for programs p01 to p03 are preset (pre). The user can change these programs.

Individual program, P--

Under the menu option P-- you have the option of creating a user defined program. This program can be changed at any time. There are up to 20 memory locations available for 10 OFF and 10 ON commands. You can allocate a corresponding weekday or week block to each memory location.

Note:

For two channels version pre-set program is established in the two channels.

P0x

Prog

Selecting pre-set programs

Sequence to follow after setting time in the Reset mode.

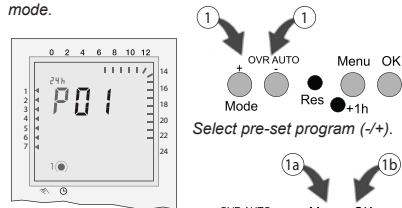

Select pre-set program (+/-).

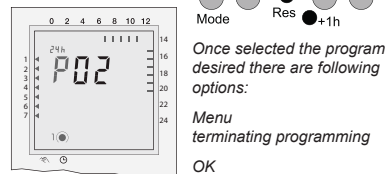

Once selected the program desired there are following options:

Menu terminating programming

OK

Going through pre-set programs to modify selection (any program ON or OFF can be modified by using "+" or "-" keys and confirming with OK) or accept it with OK key to go to the next free memory location in order to add new user defined programs.

e.g. after selecting P02 you should also program:
Sa-Su 22:30 ON (prog05)
23:00 OFF (prog06)

P--

Prog

User defined programs

Sequence to follow after setting time and weekday while running Menu mode or adding programs to the pre-set P01 to P03.

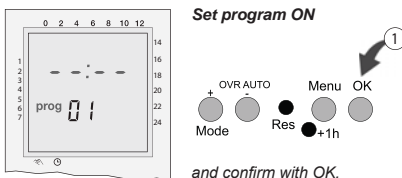

Set program ON

and confirm with OK.

P--

Prog

User defined programs

Sequence to follow after setting time and weekday while running Menu mode or adding programs to the pre-set P01 to P03.

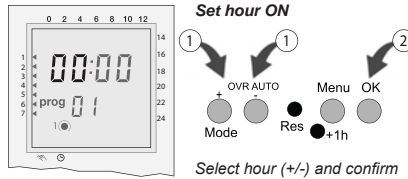

Set hour ON

Select hour (+/-) and confirm with OK.

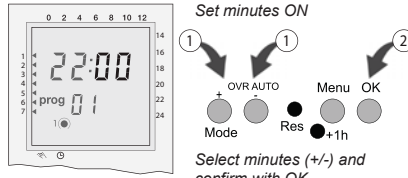

Set minutes ON

Select minutes (+/-) and confirm with OK.

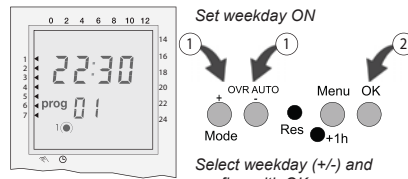

Set weekday ON

Select weekday (+/-) and confirm with OK.

Possible week blocks and individual days

1	▶	▶	▶	▶	▶	▶	▶
2	▶	▶	▶	▶	▶	▶	▶
3	▶	▶	▶	▶	▶	▶	▶
4	▶	▶	▶	▶	▶	▶	▶
5	▶	▶	▶	▶	▶	▶	▶
6	▶	▶	▶	▶	▶	▶	▶
7	▶	▶	▶	▶	▶	▶	▶

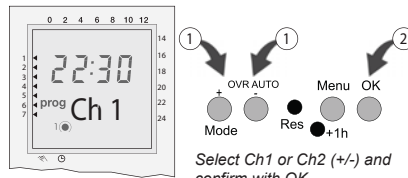

Select Ch1 or Ch2 (+/-) and confirm with OK.

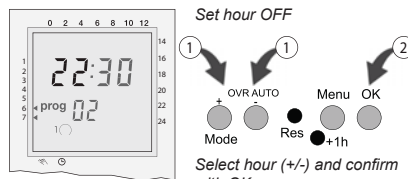

Set hour OFF

Select hour (+/-) and confirm with OK.

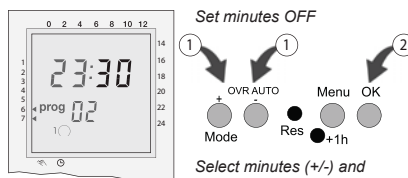

Set minutes OFF

Select minutes (+/-) and confirm with OK.

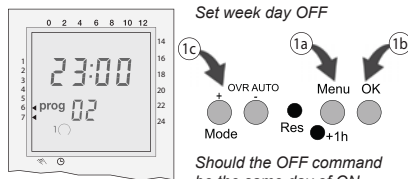

Set week day OFF

Should the OFF command be the same day of ON command then select Menu to terminate programming of select OK to go to a new program ON setting.

P--

Prog

Shift

Should the OFF command be the following day of ON command then select "+" key then select Menu or OK.

Example:

Mo-Fr 20:00 pm - 03:00 am ON → Mo-Fr 20:00 pm - 03:00 am ON
Tu-Sa 03:00 am - 20:00 pm OFF → Tu-Sa 03:00 am - 20:00 pm OFF

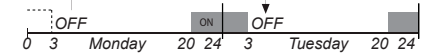

del

Deleting programs

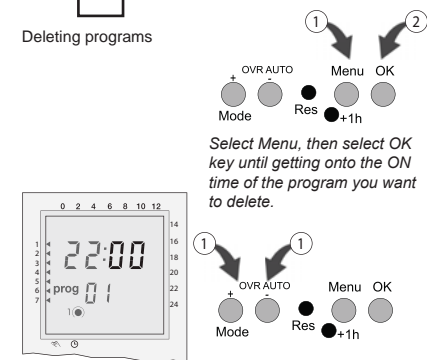

Select Menu, then select OK key until getting onto the ON time of the program you want to delete.

Select "-" with (+/-) key and confirm with OK.

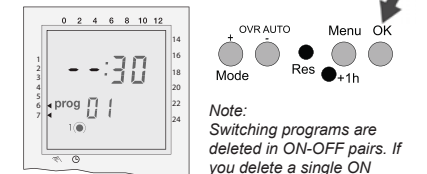

Note: Switching programs are deleted in ON-OFF pairs. If you delete a single ON instruction, the corresponding OFF instruction is also deleted.

+1h

Summer / Winter time

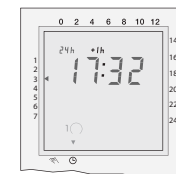

The +1h key is for the changeover from summer to winter time.

•By pressing the +1h key 1 hour is added to the current time.

•+1h is shown on the display.
•By pressing +1h again 1 hour is subtracted from the current time.

Mode

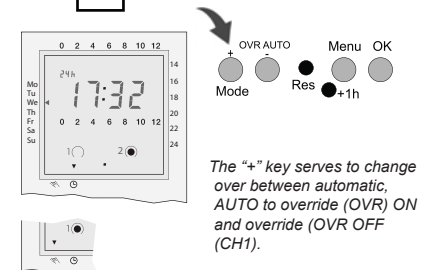

The "+" key serves to change over between automatic, AUTO to override (OVR) ON and override (OVR OFF) (CH1).

Figure 7 "HC" Wiring Diagram with Options

Models: HC-24 thru HC-72

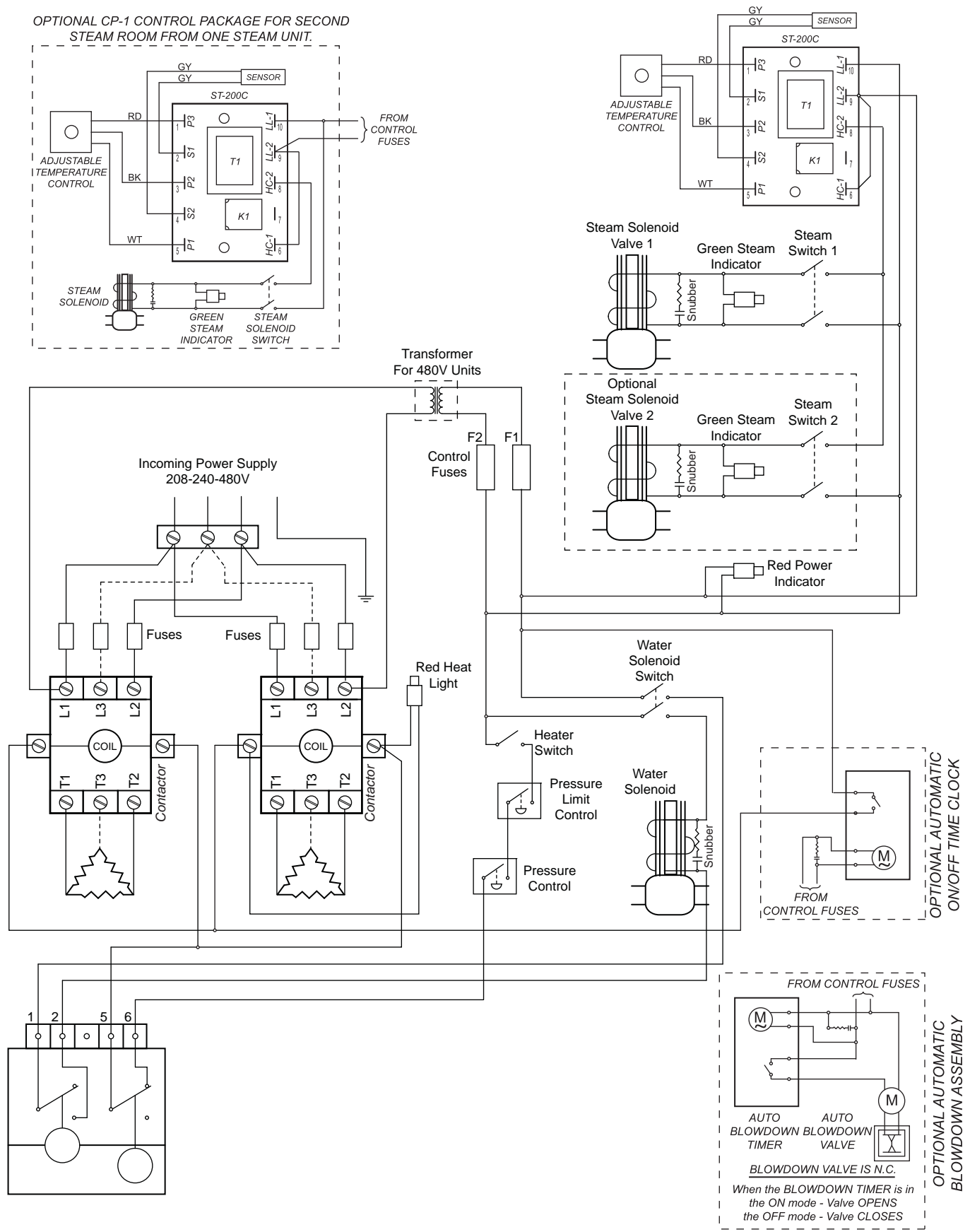

LIMITED WARRANTY

STEAMIST, INC. hereby warrants that its Steamist generators Models HC-24, HC-30, HC-36, HC-48, HC-60, and HS-72 are free from all defects in workmanship and materials for one (1) year from the date of purchase.

This warranty does not extend to damage caused by improper or negligent installation or use, or for any repairs attempted by any person other than an authorized Steamist dealer and shall be limited to the repair or replacement of defective parts by STEAMIST or its authorized dealers. After the unit has been disconnected and returned to STEAMIST's plant or to one of its authorized dealers warehouses, said repairs shall be without charge if within ninety (90) days of the date of purchase. After the expiration of ninety (90) days for the duration of the limited warranty period, there shall be a reasonable charge for labor incurred in connection with the repair or replacement indicated above.

Freight: Within the first ninety (90) days and with prior company approval, Steamist will pay all freight charges on items covered under our warranty. Thereafter and until the end of the warranty period, and with prior company approval, the customer is required to ship freight prepaid to Steamist's factory and Steamist will then ship freight prepaid back to customer.

This is not a service contract and this warranty does no include regular maintenance, cleaning or periodic check-ups, which are the sole and exclusive responsibility of the purchaser and are required as a condition of keeping this limited warranty in full force and effect.

This warranty shall not become effective unless the attached registration of Warranty is completed and returned to STEAMIST within fifteen (15) days of the date of installation.

This warranty is non-transferable and shall extend only to the original purchaser who shall have been named in the Registration of Warranty.

This warranty is void if any of the following should occur:

1. If the serial number has been altered or removed.
2. If the product is modified in any manner which STEAMIST concludes after inspection affects the reliability of the product.
3. If the product has been repaired or serviced by anyone not specifically designated and authorized by STEAMIST.
4. If the product is damaged because it is not operated or installed in accordance with supplied instructions.

The sole responsibility of STEAMIST under this warranty shall be limited to the repair of the product or replacement thereof, including parts, in the sole discretion of STEAMIST INC. The consumer's sole remedy shall be such repair or replacement as is expressly provided herein and under no circumstances shall STEAMIST be liable for any loss or damage be it direct or consequential arising out of the use or inability to use this product.

THE FOREGOING IS IN LIEU OF ALL OTHER WARRANTIES AND SPECIFICALLY EXCLUDES AND DISCLAIMS EXPRESS AND IMPLIED WARRANTIES OF MERCHANTABILITY OR OF FITNESS FOR PARTICULAR USE OF PURPOSE. THERE ARE NO WARRANTIES WHICH EXTEND BEYOND THE DESCRIPTION ON THE FACE HEREOF AND NEITHER STEAMIST NOR ITS DEALERS ASSUMES OR AUTHORIZES ANY PERSON TO ASSUME FOR ANY OF THEM ANY OTHER OBLIGATION OR LIABILITY IN CONNECTION WITH SAID EQUIPMENT.

No warranty whether express or implied is given or made with respect to any accessory supplied by anyone other than STEAMIST.

Purchaser acknowledges that no other representations were made to him or relied on by him with respect to the quality and function of the generators.

Model No. _____ **Serial No.** _____ **Date of Purchase** _____

Specifications Chart

Model No.	Product No.	KW	Max. Cu. Ft.	Volts/Phase/Amps	Wire Size* 90°C Copper AWG	Line Fuse	Water Inlet	Steam Outlet	Dimensions	Shipping Weight
HC-24	62400	24	1000	240/1/100	2	125	1/2" NPT	3/4" NPT	39"x22"x28"	200 lbs.
	62401			208/1/115	1	150				
	62402			240/3/58	4	80				
	62403			208/3/67	4	90				
	62404			480/3/29	8	40				
HC-30	63000	30	1250	240/1/125	2/0	175	1/2" NPT	3/4" NPT	39"x22"x28"	200 lbs.
	63001			208/1/144	3/0	200				
	63002			240/3/72	4	90				
	63003			208/3/84	3	110				
	63004			480/3/36	8	45				
HC-36	63600	36	1500	240/1/150	3/0	200	1/2" NPT	3/4" NPT	39"x22"x28"	200 lbs.
	63601			208/1/173	3/0	225				
	63602			240/3/87	3	110				
	63603			208/3/100	2	125				
	63604			480/3/44	6	60				
HC-48	64802	48	2000	240/3/116	1	150	1/2" NPT	3/4" NPT	39"x22"x28"	250 lbs.
	64803			208/3/133	2/0	175				
	64804			480/3/58	4	80				
HC-60	66002	60	2500	240/3/145	3/0	200	1/2" NPT	3/4" NPT	39"x22"x28"	250 lbs.
	66003			208/3/167	3/0	225				
	66004			480/3/72	4	90				
HC-72	67202	72	3000	240/3/173	3/0	225	1/2" NPT	3/4" NPT	39"x22"x28"	250 lbs.
	67203			208/3/200	4/0	250				
	67204			480/3/87	3	110				

**Above wire sizes based on 90°C copper. Always follow national electric codes.*